



5-year warranty



## Type overview

Type	DN
G250B-N	50

## Technical data

<b>Functional data</b>	Valve Size	2" [50]
	Fluid	chilled or hot water, up to 60% glycol, steam
	Fluid Temp Range (water)	20...280°F [-7...138°C]
	Body Pressure Rating	ANSI Class 250, up to 400 psi below 150°F
	Flow characteristic	modified equal percentage
	Servicing	repack kits available
	Rangeability Sv	100:1
	Max Differential Pressure (Steam)	20 psi [103 kPa]
	Flow Pattern	2-way
	Leakage rate	ANSI Class VI
	Controllable flow range	stem up - open A – AB
	Cv	40
	Maximum Inlet Pressure (Steam)	35 psi [241 kPa]
	ANSI Class	250
	Body pressure rating note	up to 400 psi below 150°F
<b>Materials</b>	Valve body	Bronze
	Valve plug	brass
	Stem	stainless steel
	Stem seal	EPDM O-ring
	Seat	Bronze
	Pipe connection	NPT female ends
<b>Suitable actuators</b>	Non-Spring	LVB(X)
	Electronic fail-safe	LVKB(X)

## Safety notes



- **WARNING:** This product can expose you to lead which is known to the State of California to cause cancer and reproductive harm. For more information go to [www.p65warnings.ca.gov](http://www.p65warnings.ca.gov)
- The valve has been designed for use in stationary heating, ventilation and air-conditioning systems and must not be used outside the specified field of application, especially in aircraft or in any other airborne means of transport.
- Only authorised specialists may carry out installation. All applicable legal or institutional installation regulations must be complied during installation.
- The valve does not contain any parts that can be replaced or repaired by the user.
- When determining the flow rate characteristic of controlled devices, the recognised directives must be observed.

**Installation notes**

**Flow direction** The direction of flow, specified by an arrow on the housing, is to be complied with, since otherwise the valve could become damaged.



**Dimensions**

Dimensional drawings



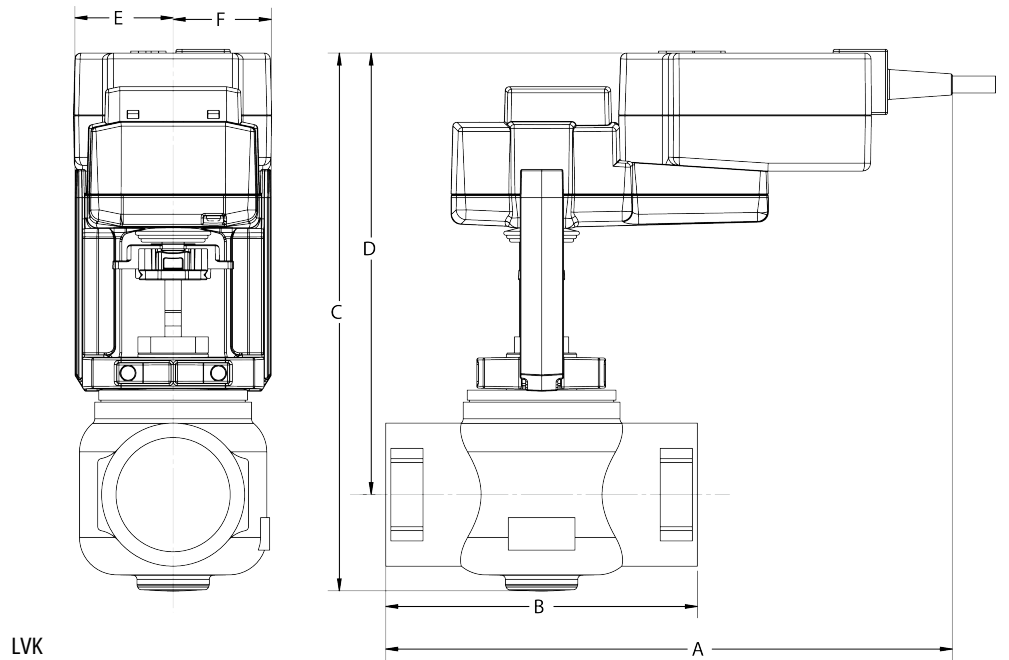

A	B	C	D	E	F
11.0" [280]	6.1" [156]	10.5" [267]	8.8" [224]	1.9" [48]	1.9" [48]



A	B	C	D	E	F
10.9" [277]	6.1" [156]	12.4" [314]	10.5" [267]	1.8" [46]	4.9" [125]





5-year warranty



## Technical data

<b>Electrical data</b>	Nominal voltage	AC/DC 24 V
	Nominal voltage frequency	50/60 Hz
	Power consumption in operation	6.5 W
	Power consumption in rest position	3 W
	Transformer sizing	9 VA (class 2 power source)
	Auxiliary switch	2 x SPDT, 3 A resistive (0.5 A inductive) @ AC 250 V, one set at 10°, one adjustable 10...90°
	Switching capacity auxiliary switch	3 A resistive (0.5 A inductive) @ AC 250 V
	Electrical Connection	(2) 18 GA appliance cables with 1/2" conduit connectors, 3 ft [1 m],
	Overload Protection	electronic throughout 0...95° rotation
<b>Functional data</b>	Operating range Y	2...10 V
	Operating range Y note	4...20 mA w/ ZG-R01 (500 Ω, 1/4 W resistor)
	Operating range Y variable	Start point 0.5...30 V End point 2.5...32 V
	Options positioning signal	variable (VDC, PWM, on/off, floating point)
	Position feedback U	2...10 V
	Position feedback U note	Max. 0.5 mA
	Position feedback U variable	VDC variable
	Direction of motion motor	selectable with switch 0/1
	Direction of motion fail-safe	reversible with cw/ccw mounting
	Manual override	5 mm hex crank (3/16" Allen), supplied
	Angle of rotation	95°,
	Running Time (Motor)	default 150 s, variable 40...150 s
	Running time motor variable	40...150 s
	Running time fail-safe	<20 s @ -4...122°F [-20...50°C], <60 s @ -22°F [-30°C]
	Override control	MIN (minimum position) = 0% MID (intermediate position) = 50% MAX (maximum position) = 100%
	Noise level, motor	50 dB(A)
	Noise level, fail-safe	62 dB(A)
Position indication	Mechanical	
<b>Safety data</b>	Degree of protection IEC/EN	IP54
	Degree of protection NEMA/UL	NEMA 2 UL Enclosure Type 2
	Agency Listing	UL 873 listed, CSA C22.2 No. 24 certified
	Quality Standard	ISO 9001
	Ambient temperature	-22...122°F [-30...50°C]
	Storage temperature	-40...176°F [-40...80°C]
	Ambient humidity	max. 95% r.H., non-condensing

Servicing

maintenance-free

Weight Weight

4.4 lb [2.0 kg]

Safety notes



- PVC W/Shld for GV w/UGLK (AM)
- Classic GM to GMB(X) retrofit bracket.
- PVC W/Shld for GV w/UGLK (LF)
- ZS-300 Mounting Bracket Set
- 120 to 24 VAC, 40 VA transformer.
- Cable for ZTH US to actuators w/o diagnostics socket.
- PC Tool computer programming interface, serial port.

Electrical installation

**✂ INSTALLATION NOTES**

- (A)** Actuators with appliance cables are numbered.
- 1** Provide overload protection and disconnect as required.
- 3** Actuators may also be powered by 24 VDC.
- 4** Two built-in auxiliary switches (2x SPDT), for end position indication, interlock control, fan startup, etc.
- 5** Only connect common to negative (-) leg of control circuits.
- 7** A 500 Ω resistor (ZG-R01) converts the 4...20 mA control signal to 2...10 V.
- 8** Control signal may be pulsed from either the Hot (Source) or Common (Sink) 24 V line.
- 10** For triac sink the Common connection from the actuator must be connected to the Hot connection of the controller. Position feedback cannot be used with a triac sink controller; the actuator internal common reference is not compatible.
- 11** Actuators may be connected in parallel if not mechanically linked. Power consumption and input impedance must be observed.
- 12** IN4004 or IN4007 diode. (IN4007 supplied, Belimo part number 40155).
- ⚡** Apply only AC line voltage or only UL-Class 2 voltage to the terminals of auxiliary switches. Mixed or combined operation of line voltage/safety extra low voltage is not allowed.
- ◆** Meets cULus requirements without the need of an electrical ground connection.
- ⚠ Warning! Live Electrical Components!**  
During installation, testing, servicing and troubleshooting of this product, it may be necessary to work with live electrical components. Have a qualified licensed electrician or other individual who has been properly trained in handling live electrical components perform these tasks. Failure to follow all electrical safety precautions when exposed to live electrical components could result in death or serious injury.

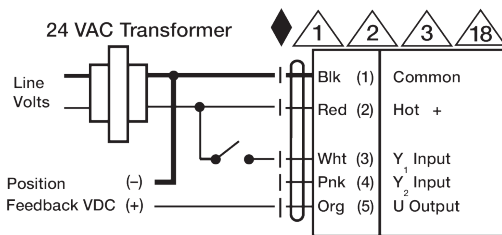

On/Off

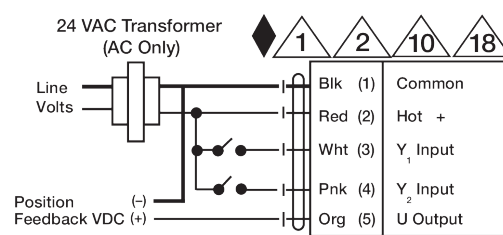

Floating Point

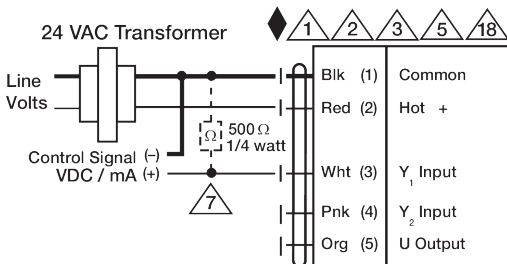

VDC/mA Control

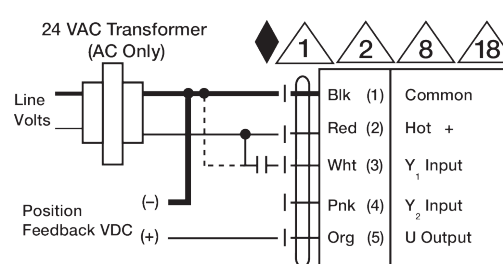

PWM Control

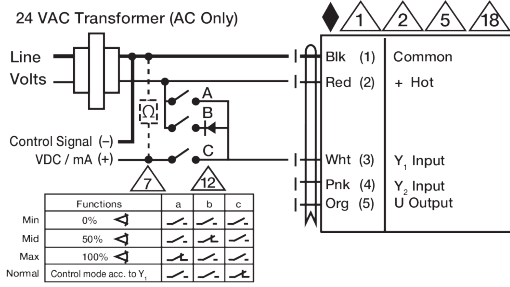

Override Control

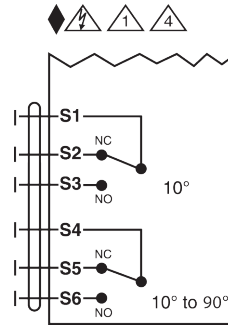

Auxiliary Switches